

L'UTILISATION DU BÉTON DANS L'IRTS

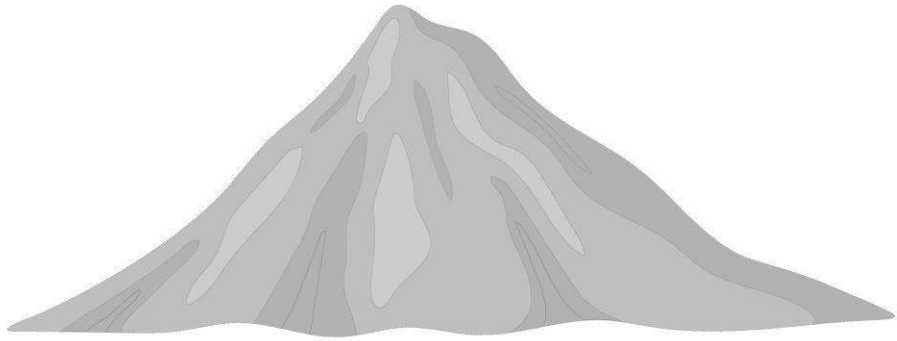

QU'EST-CE QUE LE BETON ?



Ciment

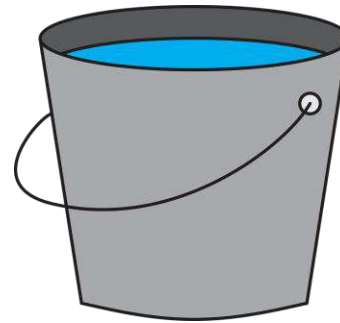

Eau

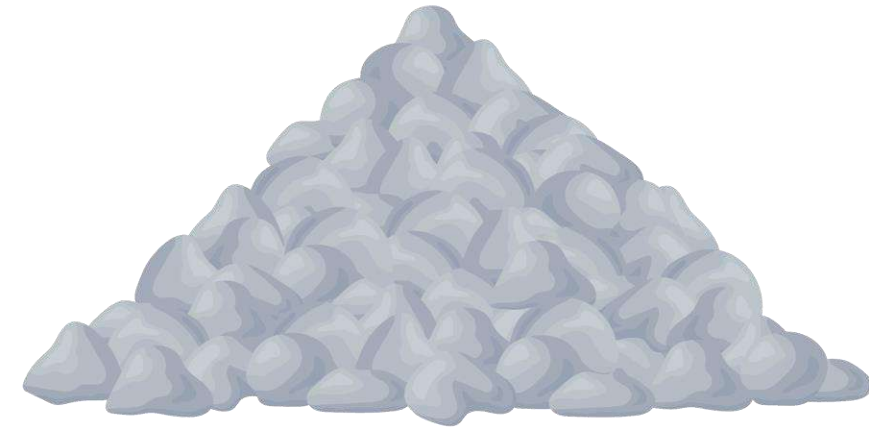

Granulat

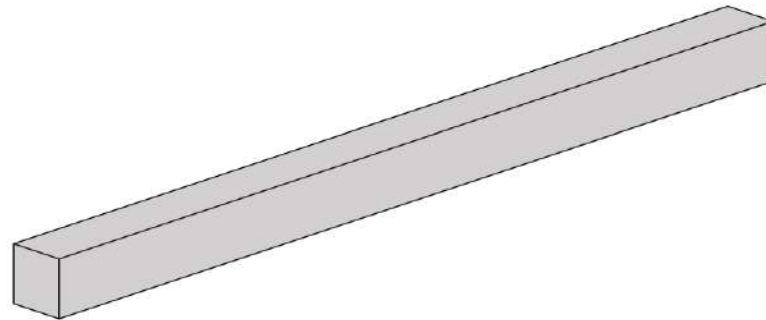

Béton

D'OÙ VIENT LE BETON ?

Création par les romains du béton antique



Le Panthéon, Rome, II^{ème} siècle . ap. J.-C

LA RENAISSANCE DU BETON AU XIX SIECLE ?

XIXème siècle Création du ciment moderne

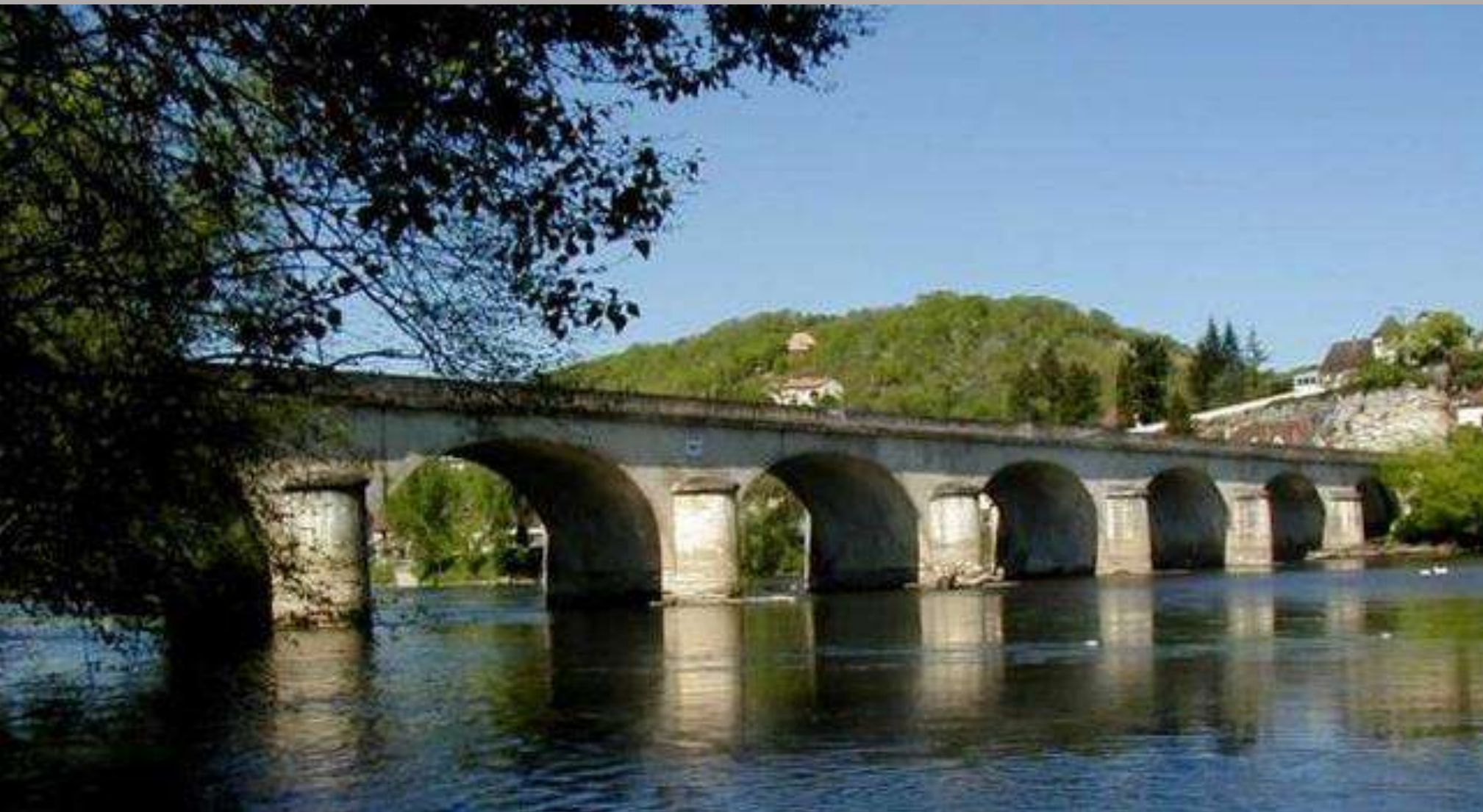

Le Pont Louis Vicat (1812-1824)



Louis Vicat 1786-1861

LA RENAISSANCE DU BETON AU XIX SIECLE ?

XIXème siècle création du béton-pise ou béton moule

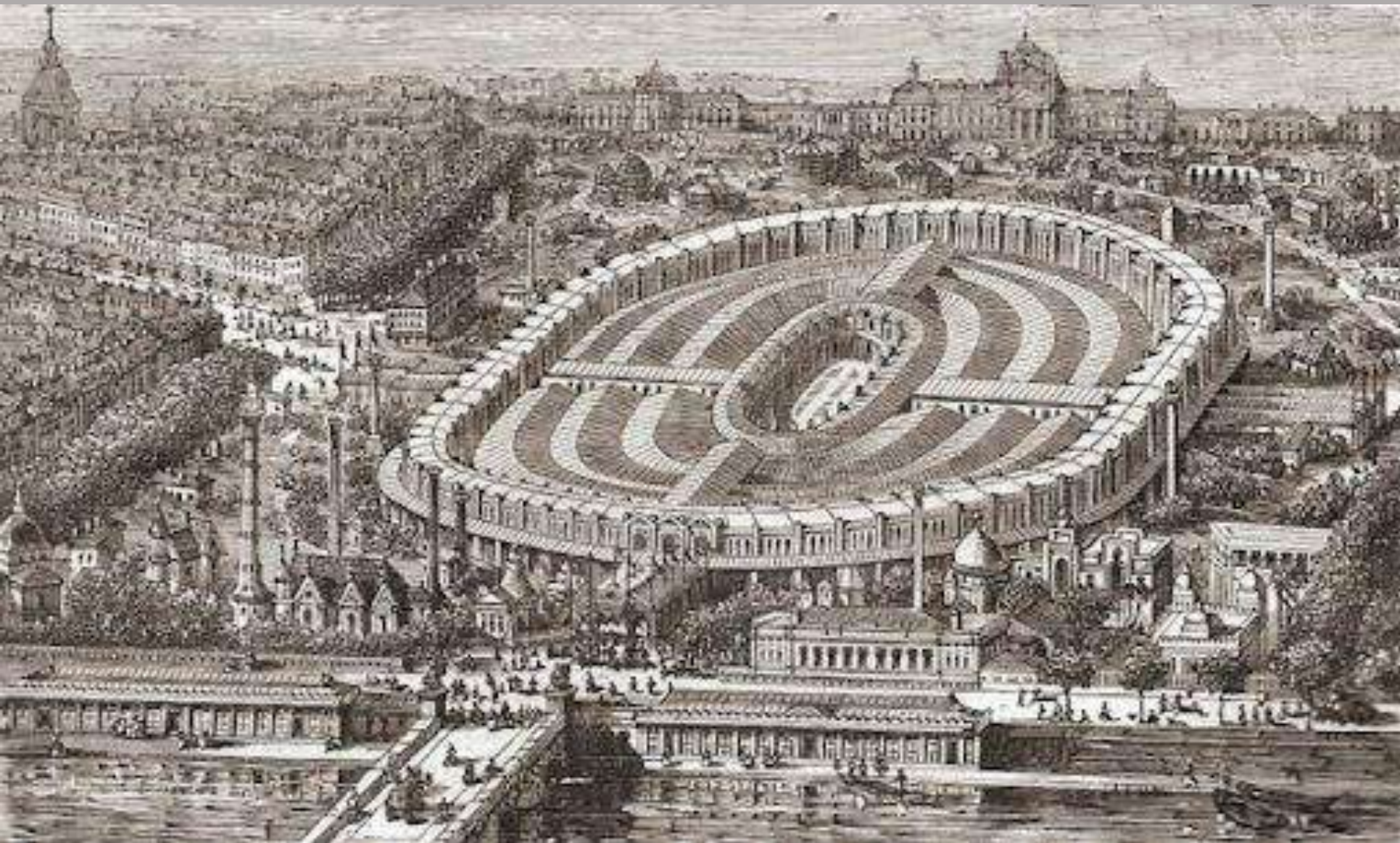

Exposition universelle de 1867, sur le champs de mars



François Coignet 1814-1888

L'ARRIVEE DU BETON ARME ?

XIXème siècle création du béton-arme

Béton sans armature

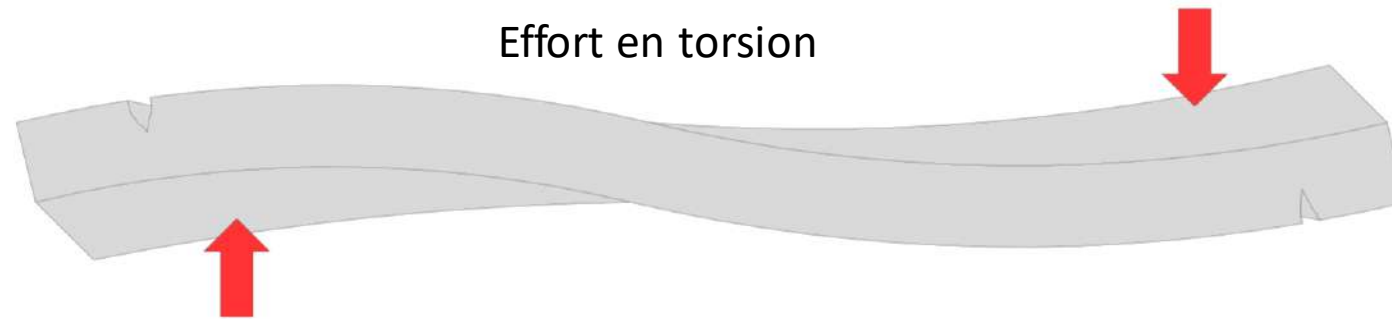
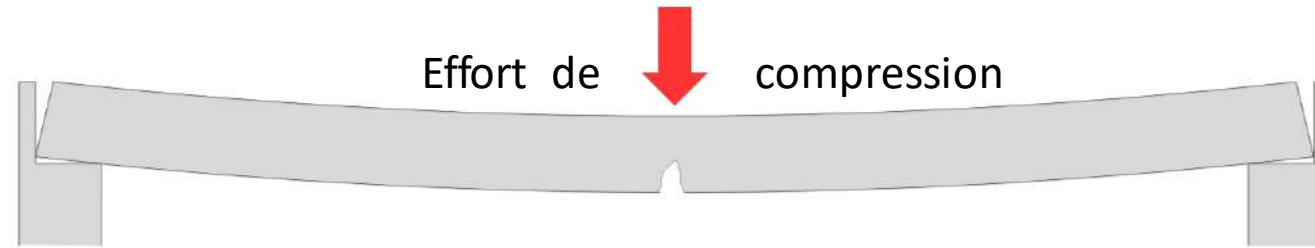

Béton armé

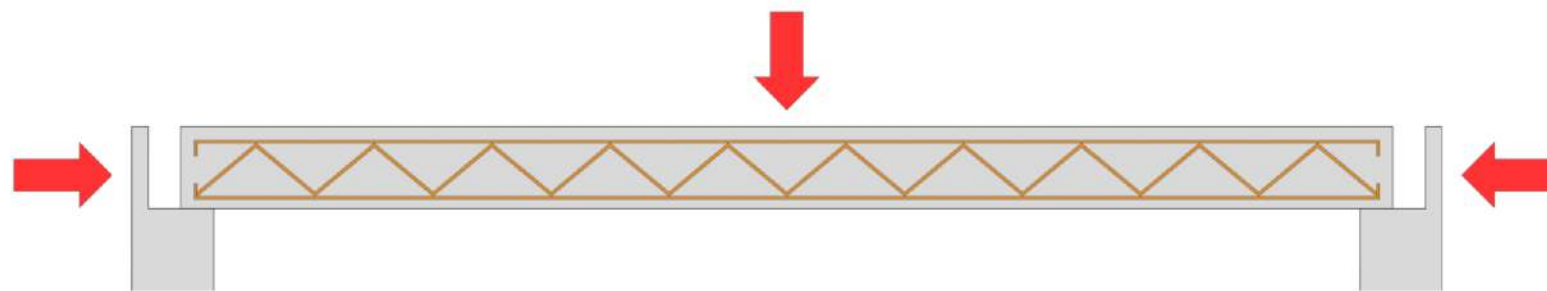

L'ARRIVEE DU BETON ARME ?

Les premières expérimentations

JOSEPH LOUIS LAMBOT 1814-1887



Barque en béton armé, Exposition Universelle de 1855

JOSEPH MONIER 1826-1903



Premier pont en béton armé château de Chazelet -1875

L'ARRIVEE DU BETON ARME ?

Les premiers bâtiments en béton armé

Premier immeuble en béton armé, François Hennebique, Paris 1893



Immeuble 25bis Rue Franklin, les frères Perret, Paris 1903



QUELS SONT LES GRANDS ARCHITECTES QUI ONT UTILISÉ LE BÉTON ?

ANTONI GAUDI 1852-1926



La Sagrada Família 1882-/
Barcelone

QUELS SONT LES GRANDS ARCHITECTES QUI ONT UTILISÉ LE BÉTON ?

FRANCK LLOYD WRIGHT 1867-1959



Ennis House, Los Angeles 1924

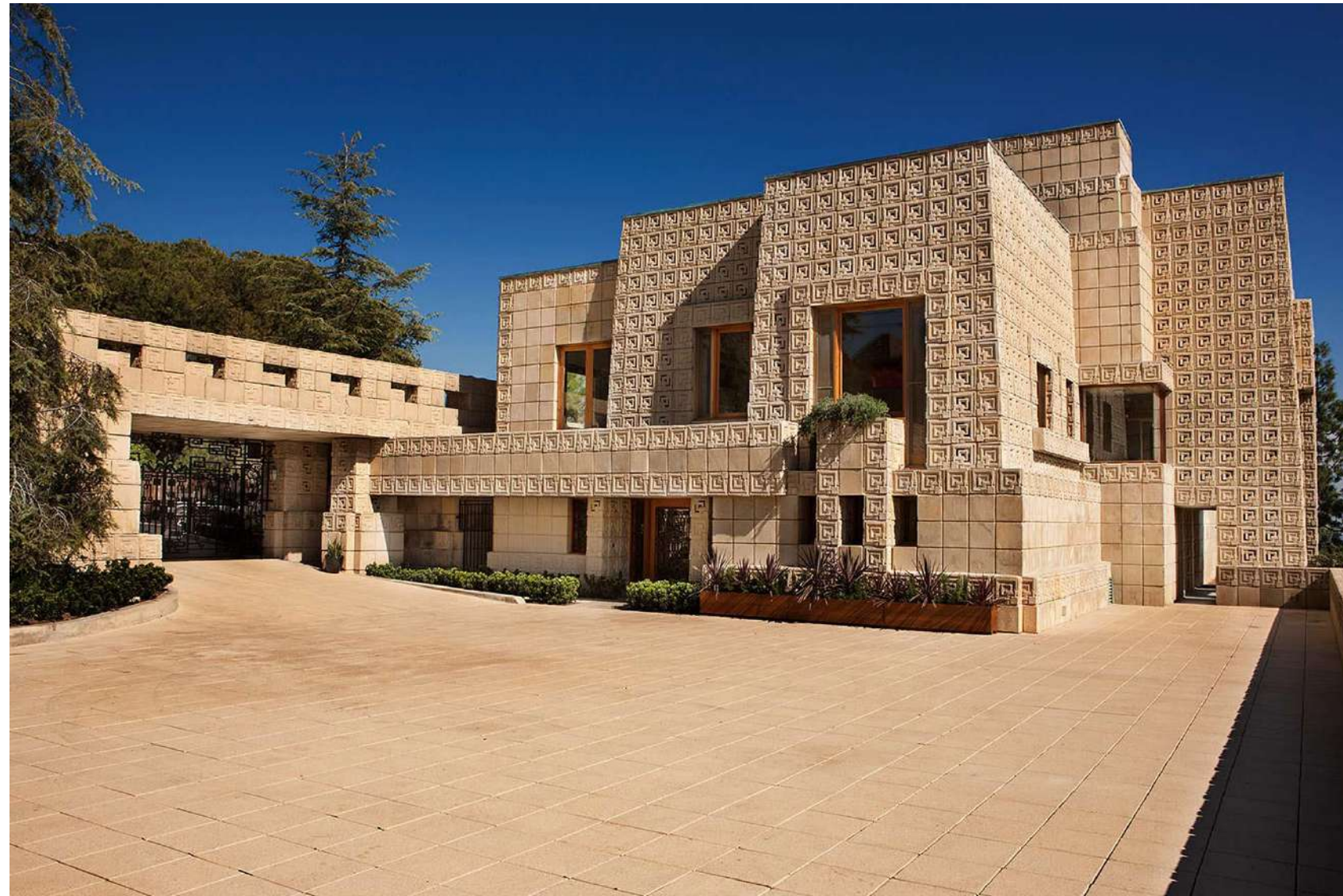

Textile Blocks



QUELS SONT LES GRANDS ARCHITECTES QUI ONT UTILISÉ LE BÉTON ?

Le Corbusier 1887-1965

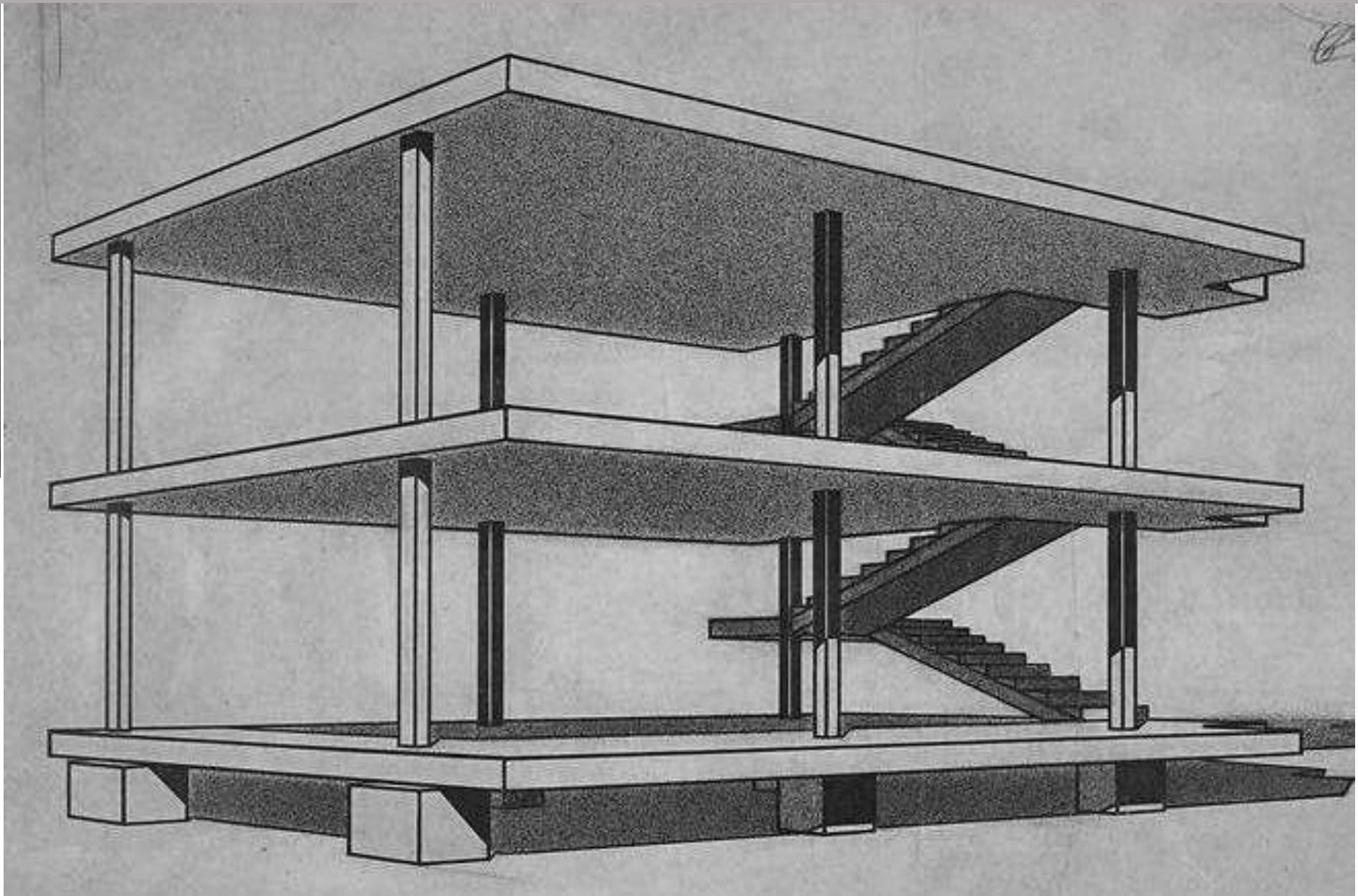

Système Dom-ino, croquis, 1914-15.

COMMENT EST UTILISE LE BETON DANS L'ARCHITECTURE MODERNE ?

LES 5 POINTS DE L'ARCHITECTURE MODERNE

- Les pilotis
- le toit-terrasse
- Le plan libre
- Les fenêtres
- la façade libre



La Villa Savoye-1928 -1931

COMMENT EST UTILISÉ LE BETON DANS L'ARCHITECTURE BRUTALISTE ?

LE BRUTALISME 1950-1970



La Cité Radieuse-
Marseille, 1952

PAR QUI A ÉTÉ CREE L'IRTS ?

EDMOND LAY 1930-2019

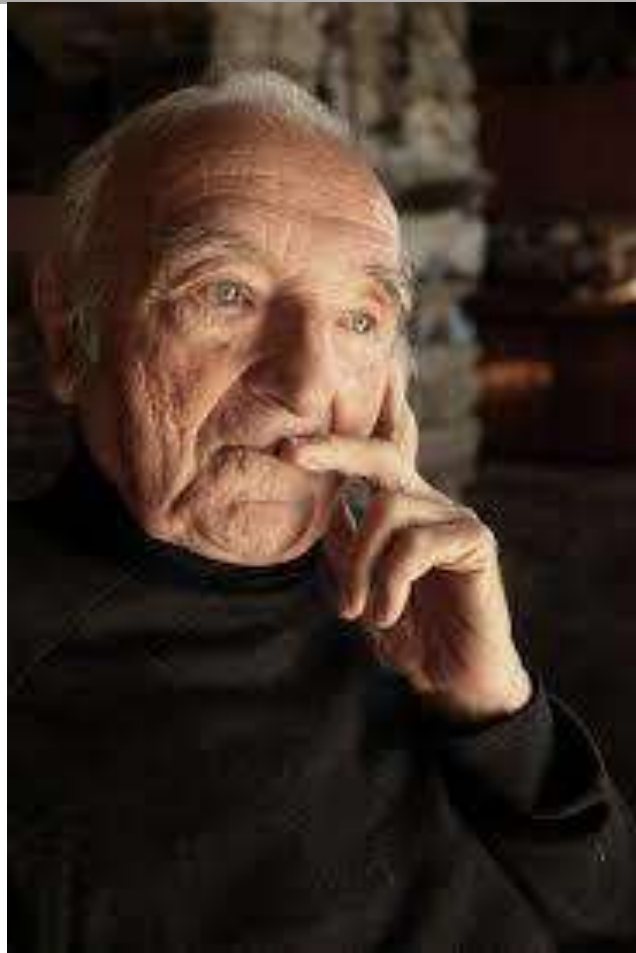

Caisse d'Epargne du quartier Mériadeck 1974-1977

LES DIFFERENTES FONCTION DU BETON DANS L'IRTS

CONSTRUCTIF ET STRUCTUREL

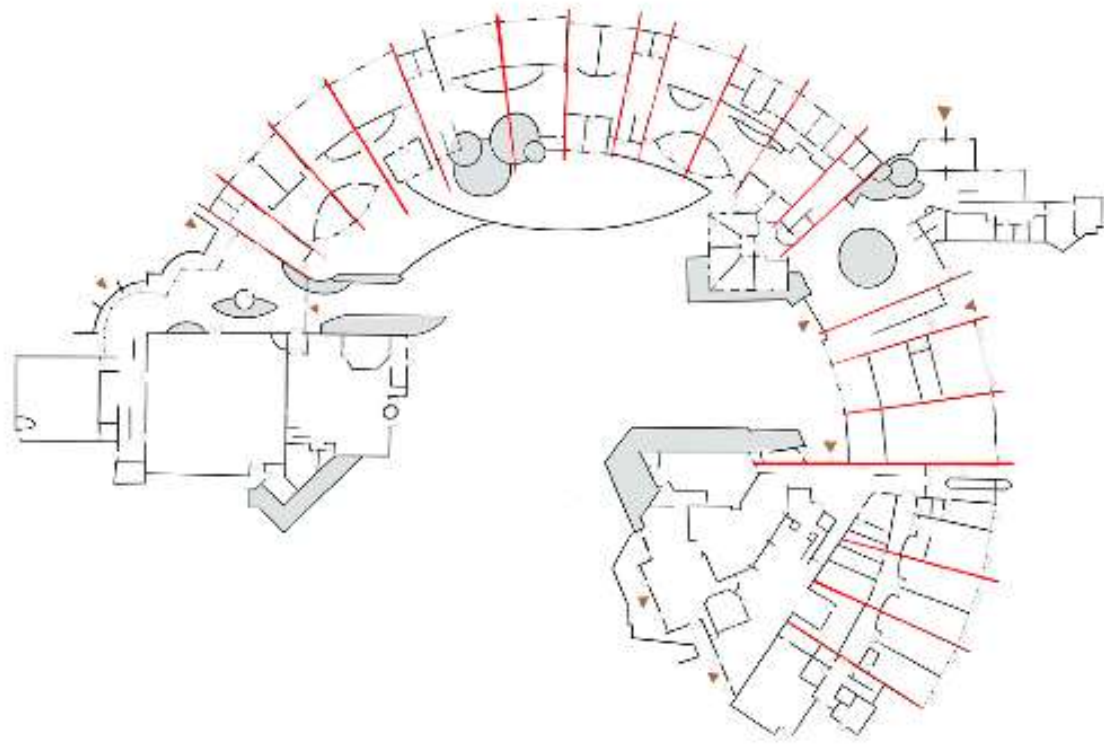

— Portiques

Plan de IRTS

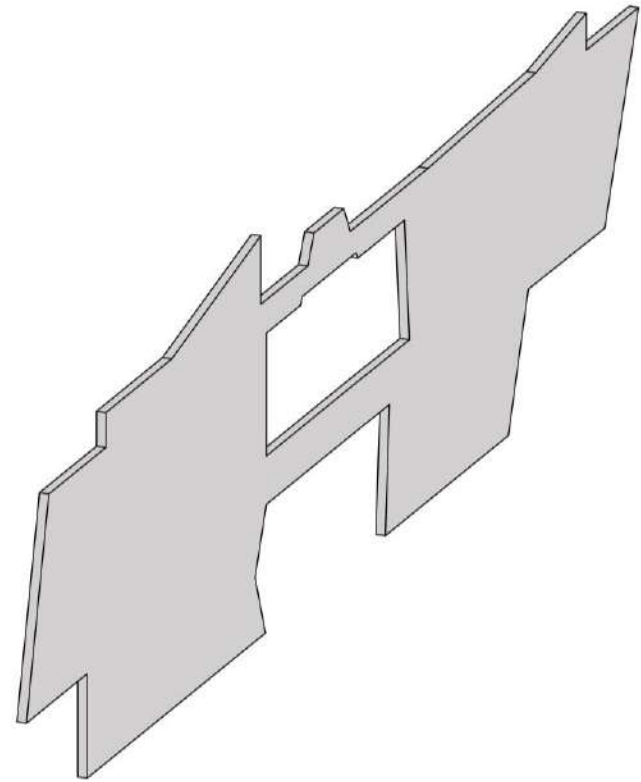

Axonométrie d'un portique

LES DIFFERENTES FONCTION DU BETON DANS L'IRTS



Photo de la partie centrale d'un portique

LES DIFFERENTES FONCTION DU BETON DANS L'IRTS

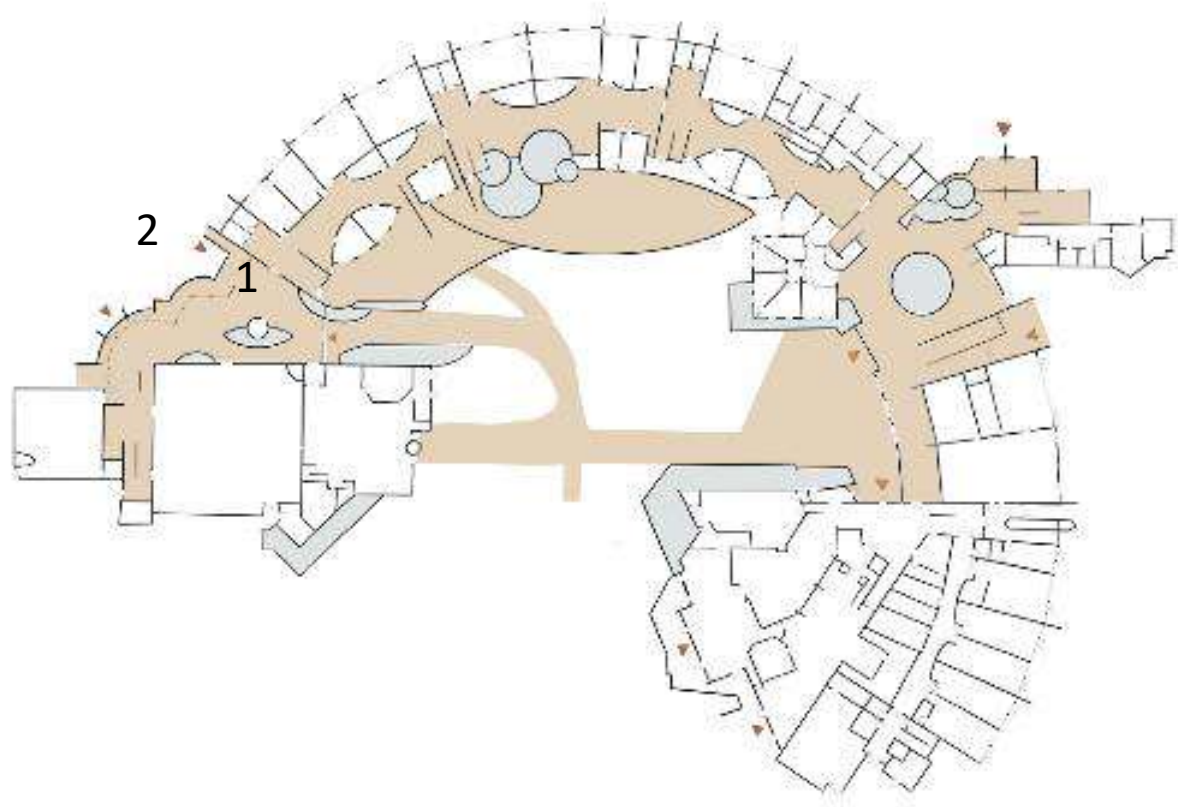

 Béton désactivé au sol

Plan de l'IRTS

1



2



LES DIFFERENTES FONCTION DU BETON DANS L'IRTS

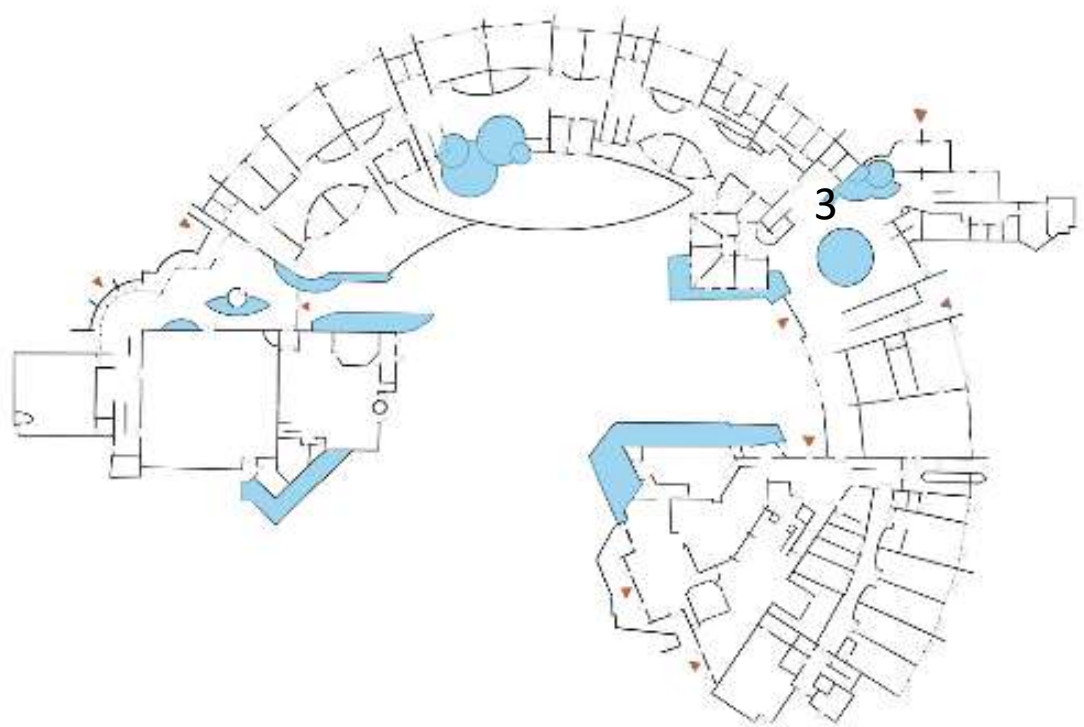

■ Jardinières et bassins

Plan de IRTS



LES DIFFERENTES FONCTION DU BETON DANS L'IRTS

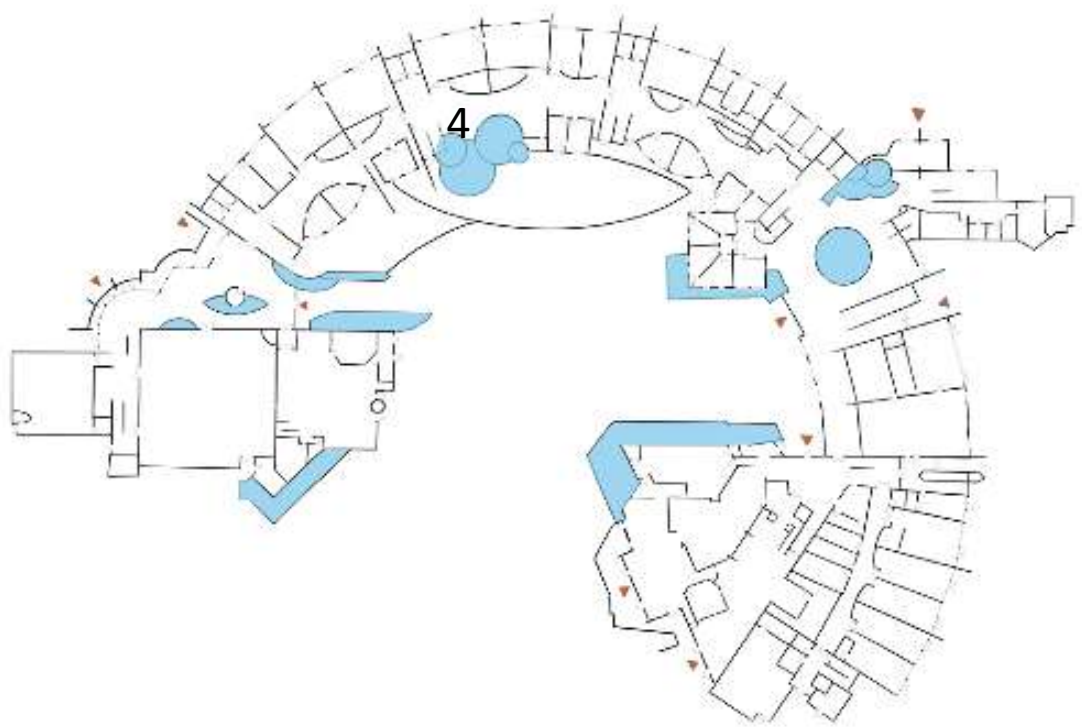

 Jardinières et bassins

Plan de IRTS



LES DIFFERENTES FONCTION DU BETON DANS L'IRTS

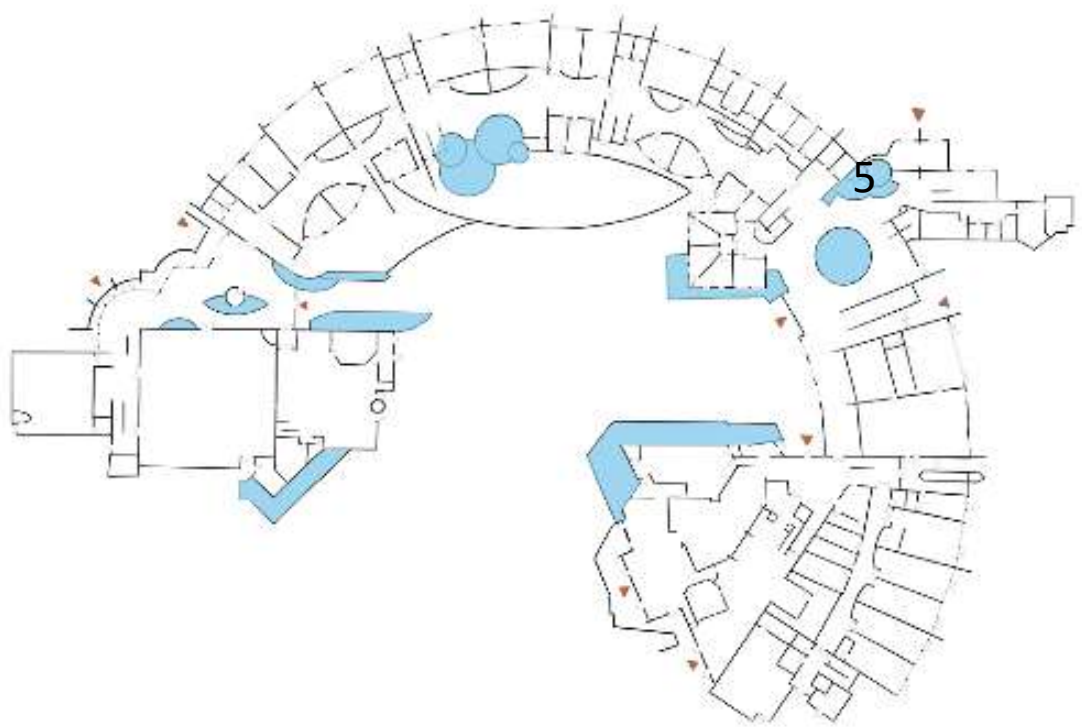

■ Jardinières et bassins

Plan de IRTS



LES DIFFERENTES FONCTION DU BETON DANS L'IRTS

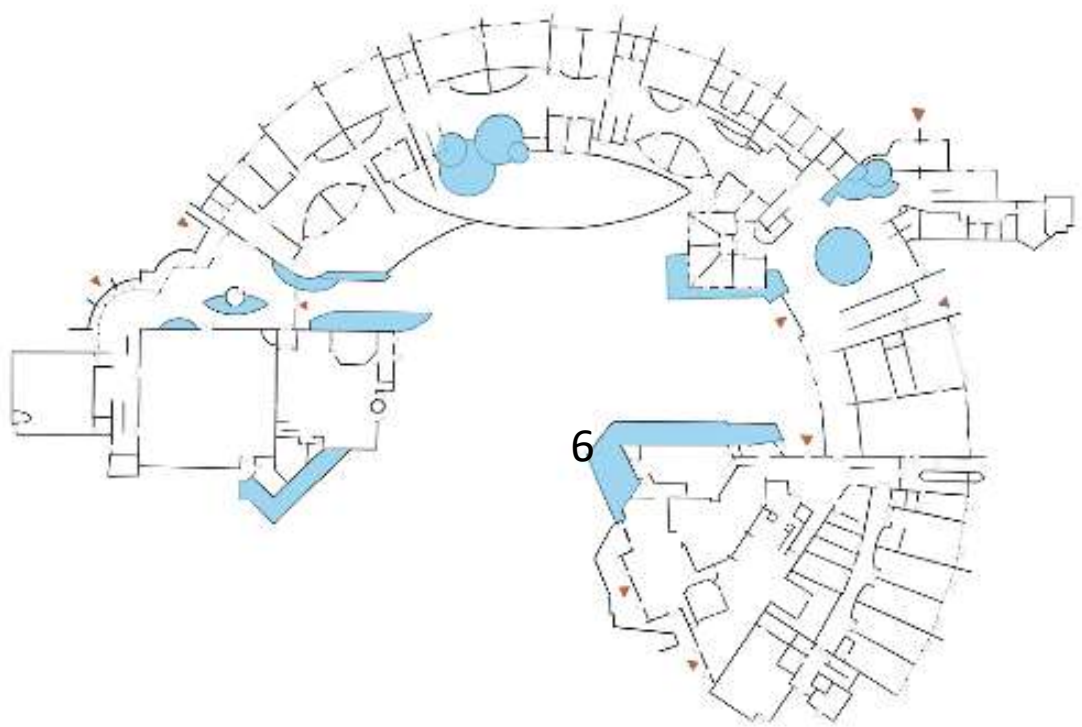

 Jardinières et bassins

Plan de IRTS



LES DIFFERENTES FONCTION DU BETON DANS L'IRTS

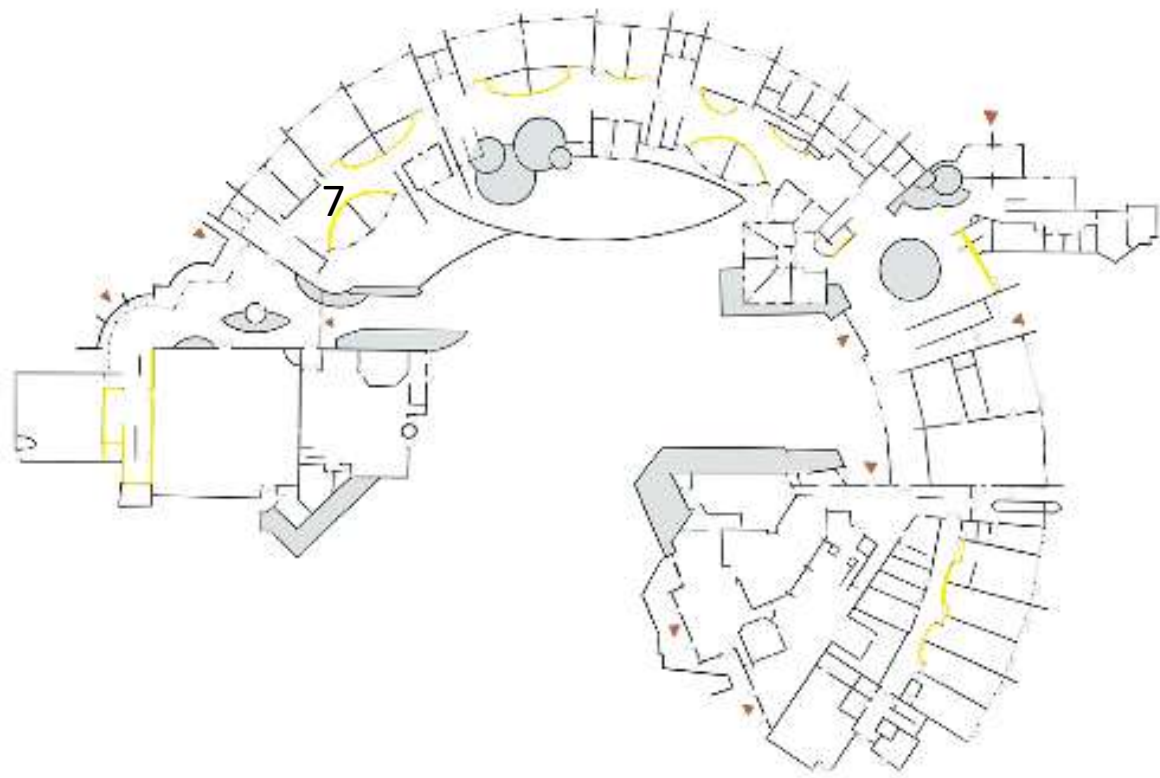

— Mur en béton enduit

Plan de IRTS



L'AVENIR DU BÉTON ?



Alexis Jourde 2021-2022
Td optionnel de médiation
Encadré par Caroline Mazel